

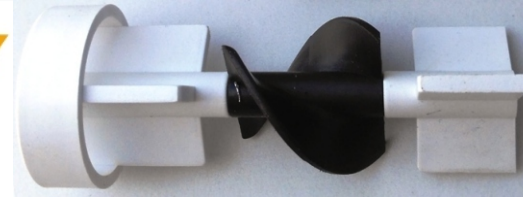

Plastic Helical Flow Sensor & Meter (Positive Displacement Flow Meter)

Flow
Level
Pressure
Temperature
Measuring
&
Control



GLOBAL
SOLUTIONS
FOR YOUR MEASURING

CE Certified
BT-PHTFS- P.P.S - size

www.broiltech.com
www.fuelsensor.in



Plastic Helical Flow Sensor & Meter (Positive Displacement Flow Meter)

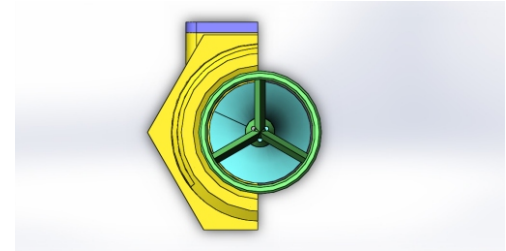
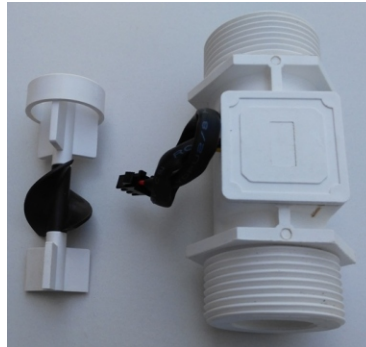

BROIL developed and produced helical rotor flow sensor specially for Liquid dispensing industries, now a day water dispensing industries use plastic turbine flow sensor its k factor change with flow rate so for solution we developer helical rotor plastic flow sensor with same pulse k factor for full range also provide very good accuracy and repeatability in full range of measurement,

Helical flow meters are positive displacement meters with a very favorable low pressure drop behavior. therefore perfectly suited for the flow measurement of very high viscosity fluids.

Due to wide measuring ranges, high accuracy and resolution helical flow meters are an excellent choice for laminating systems, painting systems, adhesive dispense systems, as well as batching systems for various fluids.

Features : High accuracy

- : Pressure: up to 25 bar
- : Independent of viscosity, perfect for 1 to 106 mm²/s
- : Low pressure drop compared with other positive displacement meters
- : High resolution
- : Pulsation-free measurement, non-sensitive to pulsating flows
- : Resistant to corrosion by advanced materials and bearings

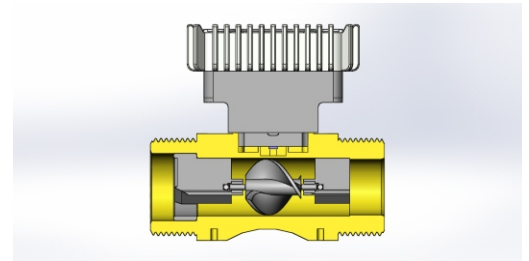

Applications : Polyurethane and polymer

- : Light and heavy fuel oil
- : Petrochemical products
- : Thixotropic fluids
- : Fat and oils with varying viscosities
- : Test rigs with varying viscosities and fluids
- : Water / glycol mixtures
- : Crude oil, furnace oil, and all viscous liquid even viscosity change with Temperature

: Very good for WATER atm, water dipensing, tea/coffee/wine/juce and other food liquied measurement and dispensing,

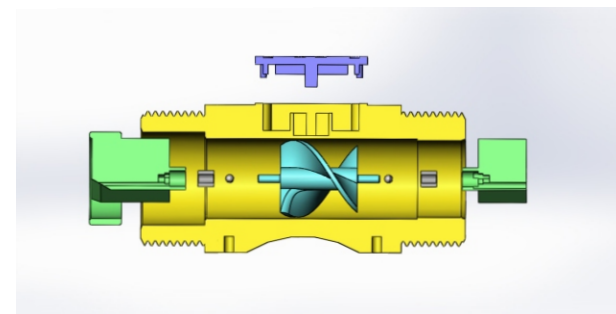

Plastic Helical Flow Sensor & Meter (Positive Displacement Flow Meter)

BT-PHTFS- P.P.S - size

Technical Data Sheet

Material of construction:

Enclosure : PA66 + GF
Rotor : PA66/POM/PPS
Shaft : Hard Stainless Steel-316
bearing : carbon/pom with hard S.S. BALL
Accuracy (standard installation position) : +/- 0.5 or 1% FSD
Repeatability : 0.05%
Maximum working pressure : 2.5 MPa
Fluid & Ambient temperature: -40 to 120 Deg. C
Connection: Thread (M)



1) Pulse output sensor :

a) Hall sensor

Power voltage: 5 to 24 V DC/ Low power: 2 to 5 V DC

Output signal: NPN open connector

Output:

high electric level : High than 4.5 VDC(input voltage 5 VDC)

low electric level : lower than 0.5 VDC(input voltage 5 VDC)

b) Reed sensor

c) pick up coil - two wire/ amplified three wire option

2) Battery operated meter :

Power voltage: 3.0 V batteries can be used more than 1 years in a row.
display mode:

Double row Liquid Crystal Display (LCD), as follows:

L XXX. X four instantaneous flow (m³ / h) or L/h

L XXXX. X Partial total (m³ / h) or L/h

XXXXX.X*100 eight cumulative flow (m³) or L

XXXXX.X*100 eight cumulative flow (m³) or L(never reset total)

Cumulative flow: automatically expand the display precision, the cumulative flow/partial values can be reset.

Power-fail protection: instrument coefficient, the Total flow values ten years is not lost when power supply drop.



3) Display with 4 to 20 mA Output

Power voltage: 24 V DC

Output signal: 4 TO 20 mA

Helical flow sensor model no wise Technical data:

<u>Model no</u>	<u>Connection(M)</u>	<u>Range</u>	<u>Pulse/Litter</u>
BT-PHTFS-004	1/4 BSP	5~40~400 L/H	3500
BT-PHTFS-008	1/2 BSP	10~150~1500 L/H	1088
BT-PHTFS-012	3/4BSP	50~500~5000 L/H	224
BT-PHTFS-020	1" BSP	80~800~8000 L/H	97
BT-PHTFS-025	1.25" BSP	100~1000~10000 L/H	54

Plastic Helical Flow Sensor & Meter (Positive Displacement Flow Meter)

BT-PHTFS- P.P.S - size

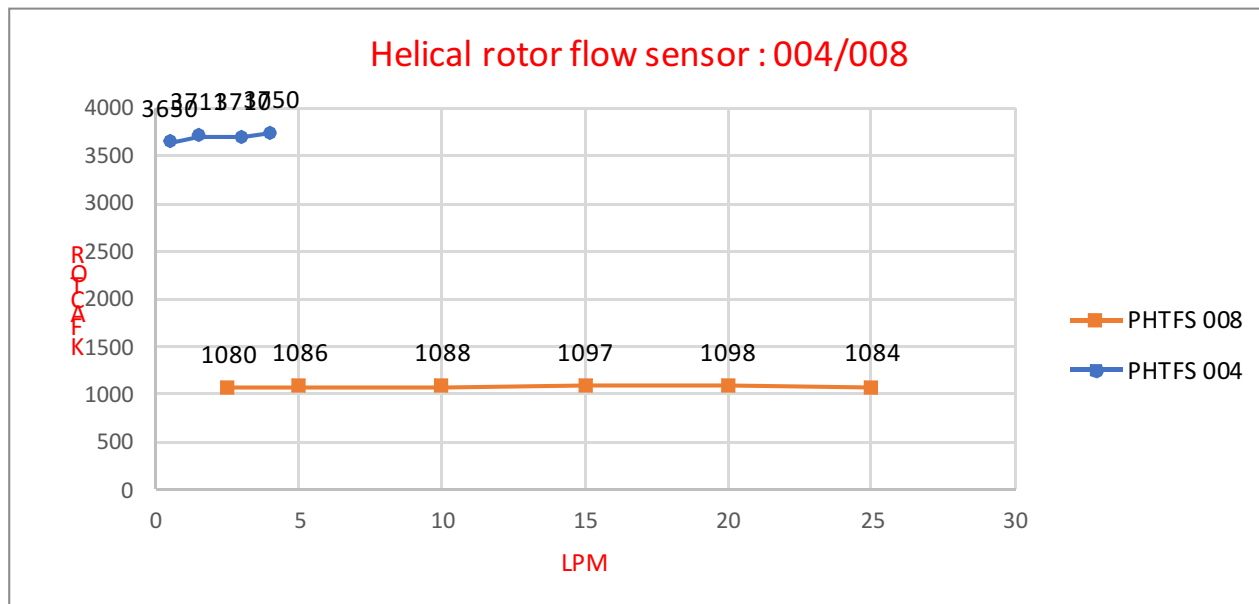
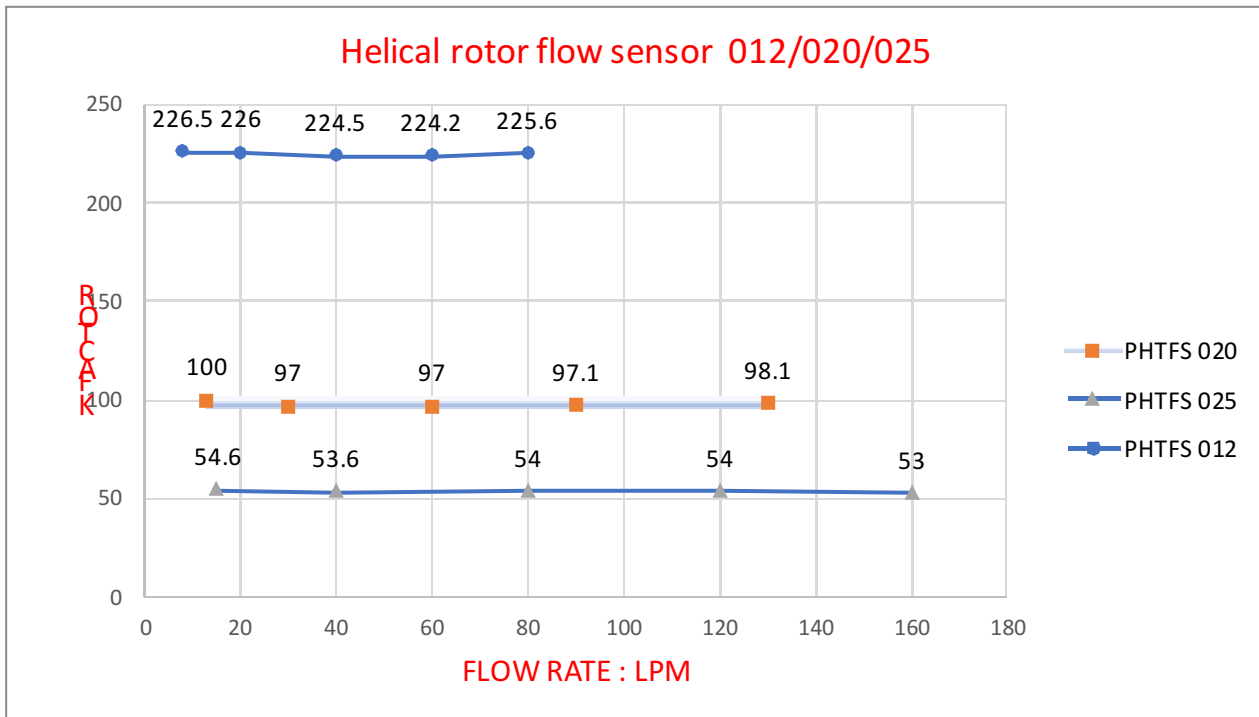

Plastic Helical Flow Sensor & Meter (Positive Displacement Flow Meter)

BT-PHTFS- P.P.S - size

Order detail with model no :

- BT-PHTFS-PPS-1- size (Hall sensor)
 - BT-PHTFS-PPS-2- size (reed sensor)
 - BT-PHTFS-PPS-3- size (pick up sensor)
 - BT-PHTFS-PPS-D- size (battery display)
 - BT-PHTFS-PPS-DA- size (display with current output 2 wire)
- size : line size

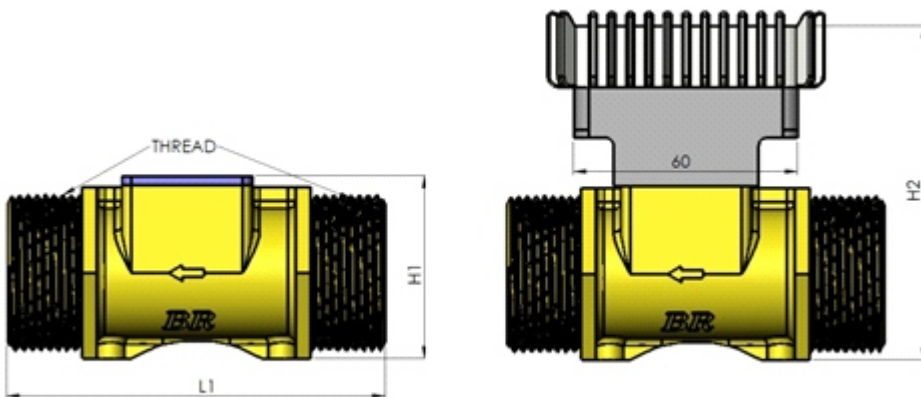

BT-PHTFS- ↓	L1	H1	Thread	H2
004	60	26.5	1/4" BSP	68.5
008	70	32	1/2" BSP	74
012	87	37	3/4" BSP	79
020	95	42.5	1" BSP	84.5
025	101.3	49	1 1/4" BSP	91

Calibration process

- *Tested each flow sensor with three pressure point : 0.5, 4 and 25 bar ,
- *all pressure calculate pulse/litter at : 25%, 50%, 75% and 100% flow rate
- *Calibrated with pure water at 25 Deg C